

Form 20533
(854)

ADJUSTERS MANUAL

FOR

SINGER

SEWING MACHINES

OF

CLASS 20

SINGLE THREAD CHAIN STITCH



THE SINGER MANUFACTURING COMPANY

Printed in U.S.A.

ADJUSTERS MANUAL
FOR
SINGER
SEWING MACHINES
OF
CLASS 20
SINGLE THREAD CHAIN STITCH



THE SINGER MANUFACTURING COMPANY

Copyright, U. S. A., 1936, 1952 and 1954, by The Singer Manufacturing Company
All Rights Reserved for all Countries

*A Trade Mark of THE SINGER MANUFACTURING COMPANY

INDEX

DESCRIPTION	3
CAUSES OF NEEDLE BREAKAGE	15
CHAIN STITCH (SINGLE THREAD)	
Formation of	6, 7
CLOTH PLATE—To Remove and Replace	10
FEED—To Time	9
FEED DOG—To Remove and Replace	11
FEED ECCENTRIC	
To Locate	9
To Remove and Replace	11
HAND WHEEL	
To Adjust for End Play	13
To Remove and Replace	14
LENGTH OF STITCH—To Regulate	8
LOOPER	
To Locate	9
To Remove and Replace	10
LUBRICATION	14
MOTOR	
To Change Speed of	16
To Oil	14
To Start and Stop	16
NEEDLE	
Causes of Breakage	15
Description of	4
Relation to Presser Foot and Cloth Plate	15
To Set	5
NEEDLE BAR—Remove and Replace	11, 12
PREPARE MACHINE FOR SEWING	3
PRESSER BAR—To Remove and Replace	13
SUGGESTIONS TO SERVICEMAN	
Order of Inspection	14, 15
SPEED—To Change	16
TENSION—To Regulate	8
THREAD NIPPER	8

TO ALL WHOM IT MAY CONCERN:

The improper placing or renewal of the Trade Mark "SINGER" or any other of the Trade Marks of The Singer Manufacturing Company (all of which are duly Registered Trade Marks) on any machine that has been repaired, rebuilt, reconditioned, or altered in any way whatsoever outside a SINGER factory or an authorized SINGER agency is forbidden.

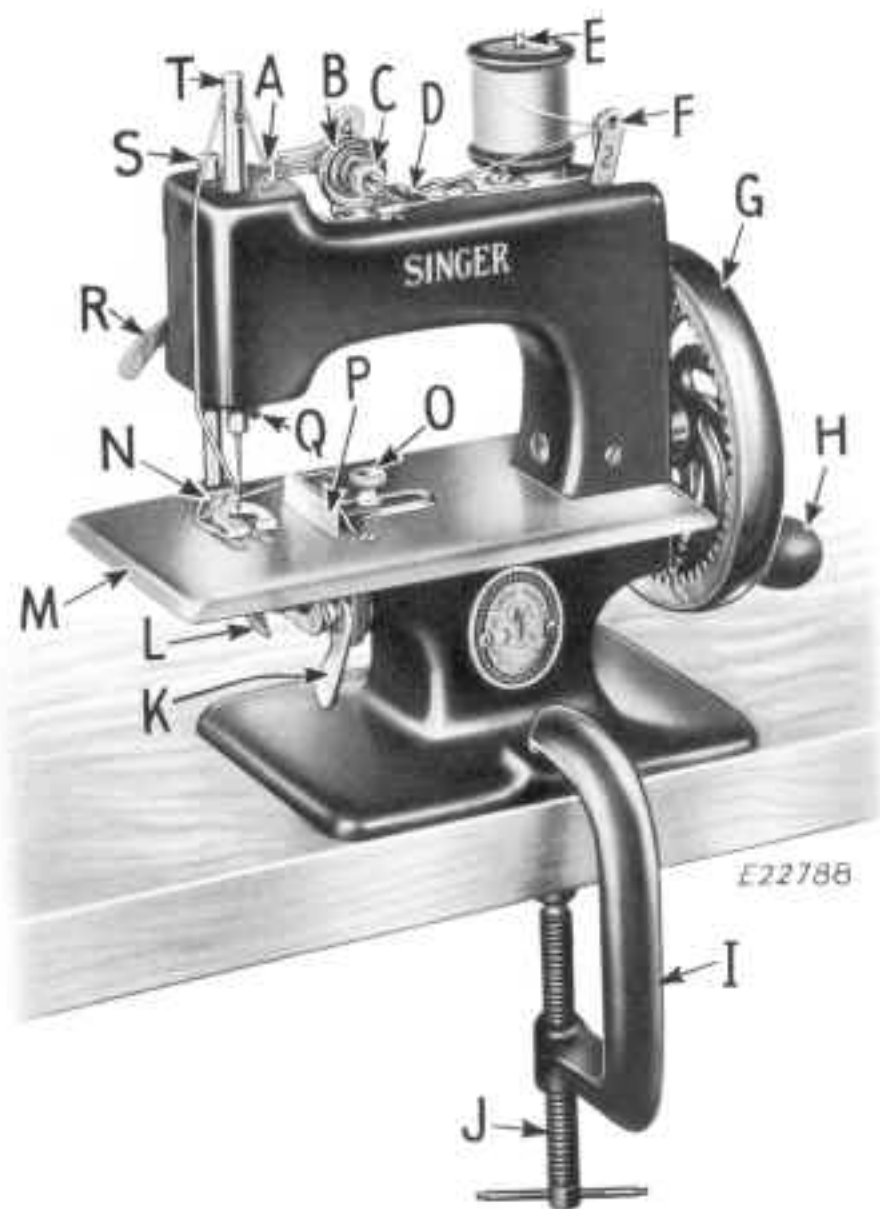

Fig. 2. Principal Parts of Machine 20-10

- | | |
|-----------------------------------|----------------------------|
| A. Thread Hole in Tension Bracket | J. Clamp Screw |
| B. Tension Discs | K. Stitch Regulator |
| C. Tension Regulating Thumb Nut | L. Loper |
| D. Thread Nipper | M. Cloth Plate |
| E. Spool Pin | N. Presser Foot |
| F. Thread Pull Off | O. Cloth Guide Thumb Screw |
| G. Hand Wheel | P. Cloth Guide |
| H. Driving Handle | Q. Needle Set Screw |
| I. Clamp | R. Presser Bar Lifter |
| | S. Presser Bar |
| | T. Needle Bar |

DESCRIPTION

Machines of Class 20 are practical, convenient, **single thread chain stitch** sewing machines made especially for children. They may also be used by adults for repairing clothes and light household articles.

Machines 20-1 and **20-10** are operated manually. **Machine 20-2** is operated by motor, although it too can be operated manually by removing motor and attaching a handle to hand wheel.

All **Machines of Class 20** have a cloth guide for use when sewing close to edge of material.

The rotary looper makes one revolution per stitch.

The needle is threaded from left to right.

An arm side cover encloses movable parts of arm of **Machine 20-10**.

A clamp, for fastening machine to a table or desk, is furnished with all **Machines of Class 20**.

All electrical parts of motor of **Machine 20-2** are enclosed in a bakelite shell, eliminating the danger of electrical shock.

The motor requires no attention except occasional oiling. It must be used only on **110 volt, 60 cycle, alternating current (A. C.)**.

TO PREPARE MACHINE FOR SEWING

1. Inspect for possible damage incurred during transit. Bent shaft, broken wheel, etc.
2. Check machine for free turning qualities.
3. Rinse with Varsol, then wipe off all traces of tacky, anti-rust oil used to protect polished and plated surfaces.
4. Oil machine completely. **See page 14.** Wipe away any surplus oil.
5. Check condition of needle before making sewing tests. **See item 4, top of page 15.**
6. Check timing of feed and position of looper in relation to needle. **See page 9.**
7. Check looper shaft for correct amount of end play. **See page 9.**
8. Check hand wheel for correct amount of end play. **See page 13.**
9. Glazed cotton thread is recommended for improved sewing results.
10. Sew-in machine and check stitching. **See page 8.**

DESCRIPTION OF 24 X 1 NEEDLES

Needles for **Machines of Class 20** are of **Class and Variety 24 x 1** in **Sizes 9, 11, 14 and 16**.

The size of needle to be used depends upon the size of the thread which must pass freely through eye of needle.

Do not use rough or uneven thread or thread which passes with difficulty through needle eye, as such thread will interfere with the successful use of the machine.

Although needles are made with **different diameter of blades**, **certain dimensions remain constant** for all needles of the same **Class and Variety**.

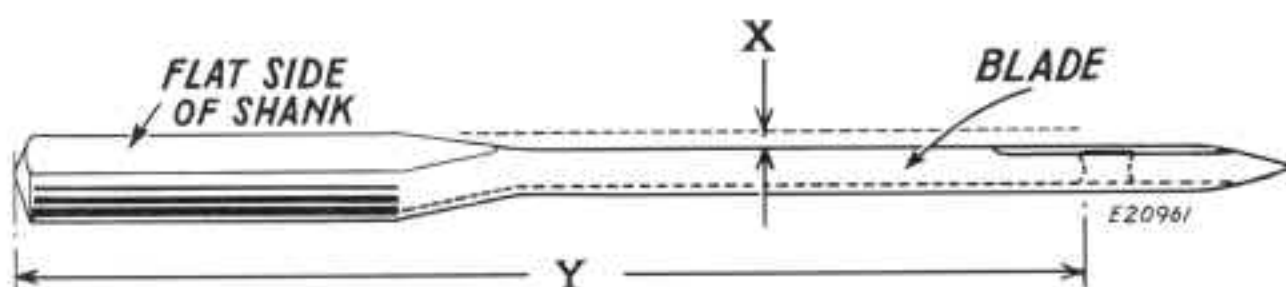

Fig. 3. Needle Distances

For example, the distance **X** between the short-grooved side of needle blade and the position of the flat-side of the needle shank, seated in needle bar, is constant, maintaining an identical relationship between short-groove side of all 24 x 1 needles and looper point. Therefore, any increase in **diameter** of blade results in a shifting of only the **centerline** of needle blade away from looper point.

Another constant is distance **Y** from end of shank to top of eye, maintaining an identical relationship between needle eye and looper point, **during formation of thread loop**.

However, the size of needle eye increases with the size of needle to accommodate heavier thread. Therefore, any **increase** in the length of a 24 x 1 needle is made from the **top of the needle eye toward the point of the needle**.

HOW TO CHECK A NEEDLE FOR STRAIGHTNESS

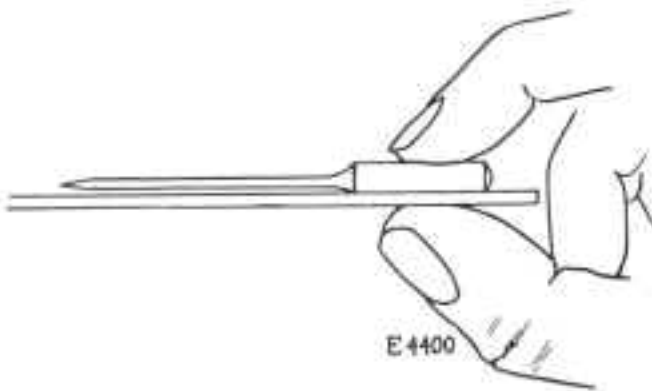

Fig. 3A. Checking Needle

Place flat side of needle on cloth plate or any other flat solid surface and hold up to light, as shown in Fig. 3A. A straight needle will show an even amount of light under it and point will be in line with shank.

TO SET NEEDLE IN NEEDLE BAR

Turn hand wheel over away from operator until needle bar reaches its highest point. Loosen needle set screw **A**, Fig. 4. With flat side of needle to the right, as shown in Fig. 4, insert needle up into needle bar as far as it will go and tighten set screw **A**.

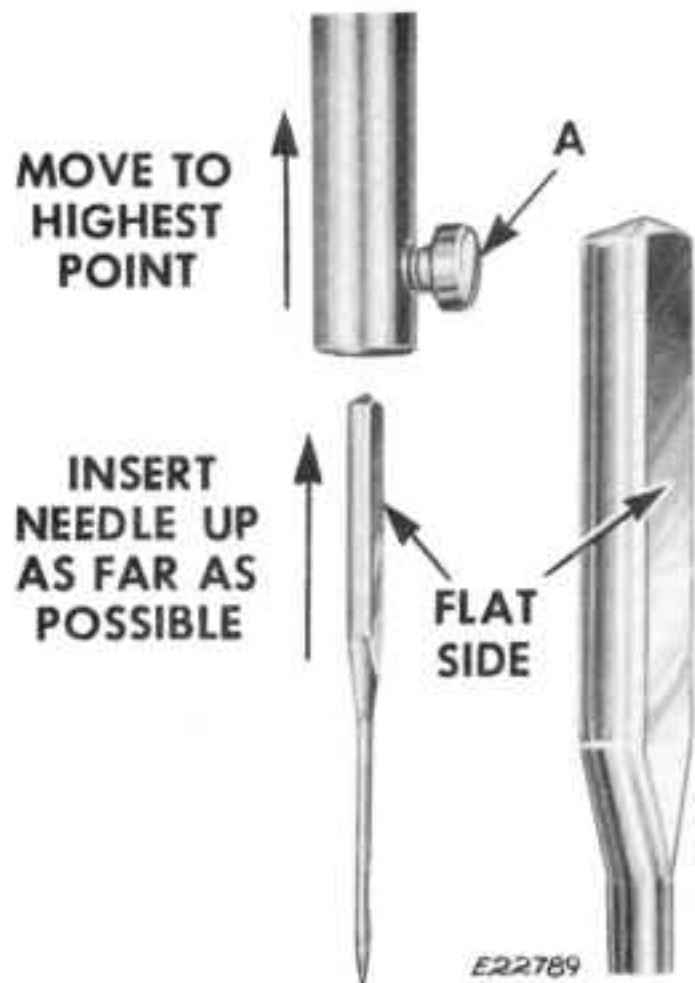

Fig. 4. Setting the Needle

FORMATION OF SINGLE THREAD CHAIN STITCH

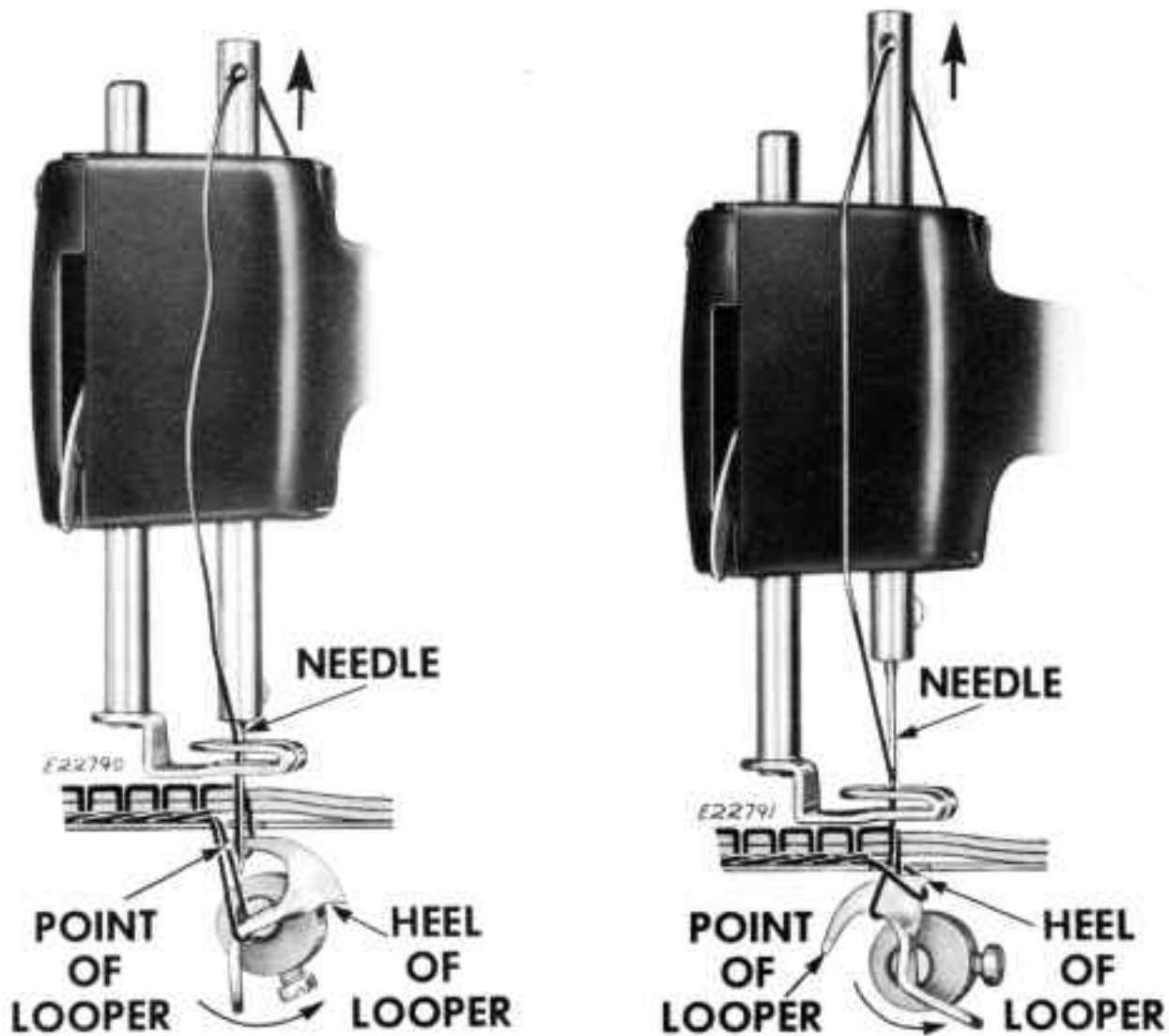

Fig. 5. Loper Entering Loop of Needle Thread

Fig. 6. Loop Being Carried Through Previous Loop

Fig. 5 shows the first stage in stitch formation. The needle, after descending to its lowest point, has been slightly raised and a loop of thread is thus formed which is immediately entered by point of looper and carried by it into the preceding loop.

Fig. 6 shows the second stage. The loop of thread is being carried by point of looper down through preceding loop. The heel of looper is about to release preceding loop.

FORMATION OF SINGLE THREAD CHAIN STITCH (Continued)

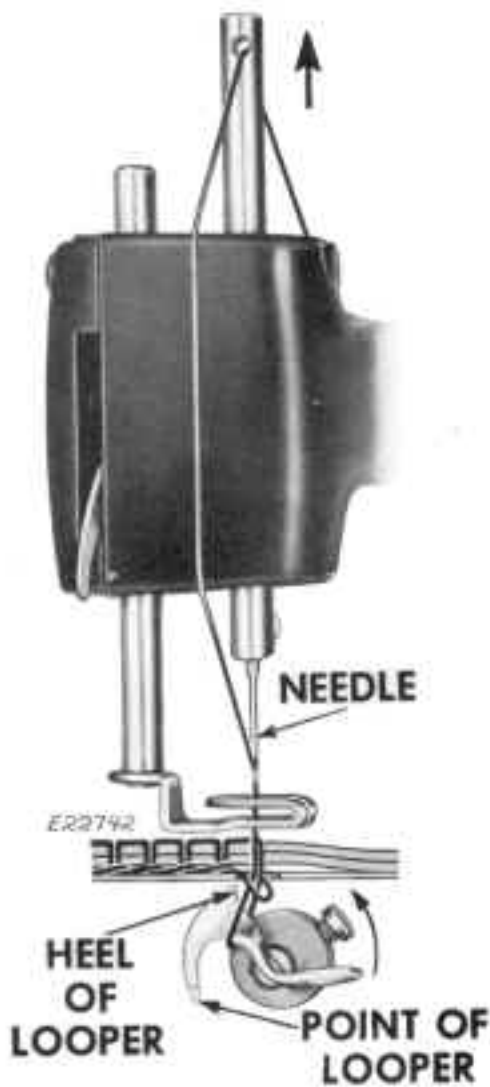

Fig. 7. Loop Enlarged and Previous Loop Drawn Up

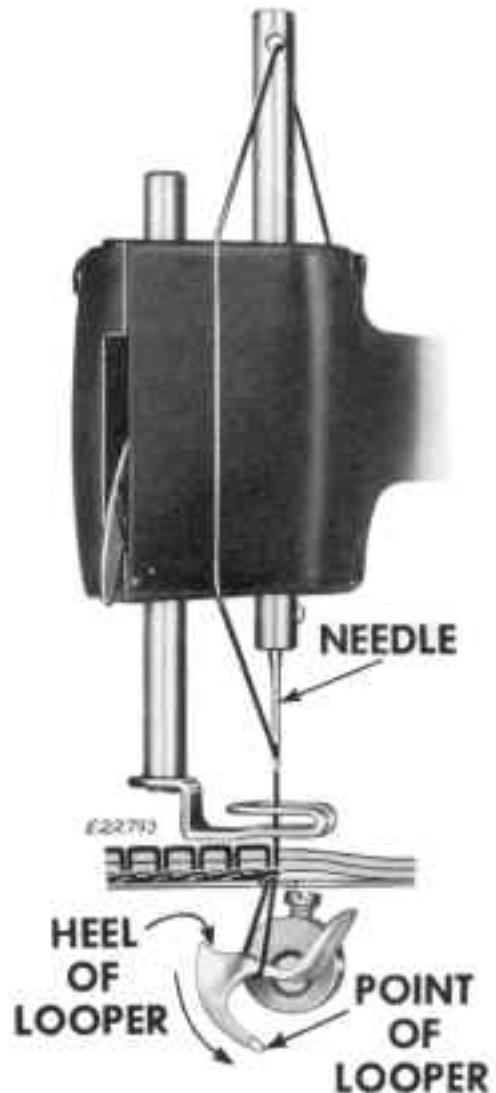

Fig. 8. Loop Further Enlarged and Previous Loop Completed

Fig. 7 shows the third stage. The loop is further enlarged by the downward movement of point of looper. The preceding loop has been released and is being drawn closer to fabric by movement of looper, assisted by the raising of needle bar.

Fig. 8 shows the completed stitch. The loop of the stitch in process is drawn down to its fullest extent by looper. The preceding stitch has been drawn closely against the underside of fabric and is completed, the needle bar having reached its highest point.

TO REGULATE TENSION ON THREAD

Tension on thread, once regulated, seldom requires changing.

The thread nipper spring **B**, Fig. 9 is automatically controlled by needle bar lever at **C**, Fig. 9. The nipper is opened just before needle bar reaches its highest point and remains open until needle bar has drawn off sufficient thread for next stitch.

The thread nipper should open to approximately $1/32''$ when needle bar is at its highest point.

If puckering or thread breakage occurs at **light tension settings**, raise needle bar to highest point and check nipper opening. If necessary, reshape contact finger of nipper so that correct opening is obtained.

If stitches are so tight that they pucker material, decrease tension by turning thumb nut **E**, Fig. 9 over to the **left** (counter-clockwise). If stitches are too loose, increase tension by turning thumb nut **E** over to the **right** (clockwise).

Note:—If thread bearing surfaces are rusted, they should be replaced.

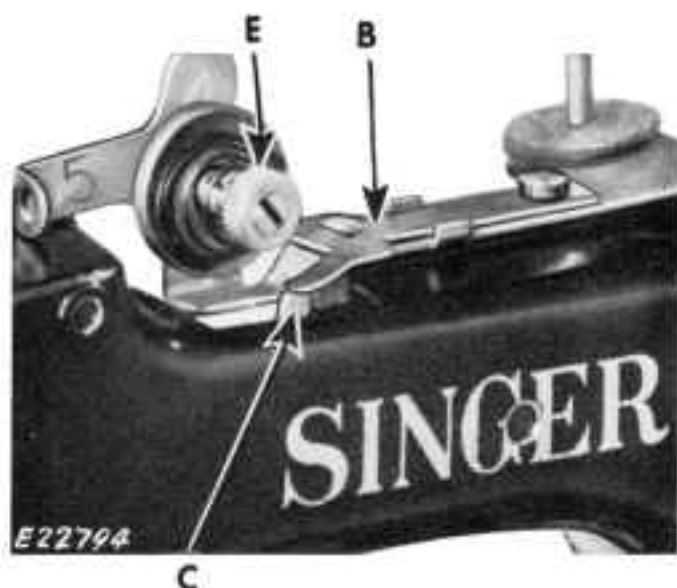

Fig. 9. To Regulate Tension

TO REGULATE LENGTH OF STITCH

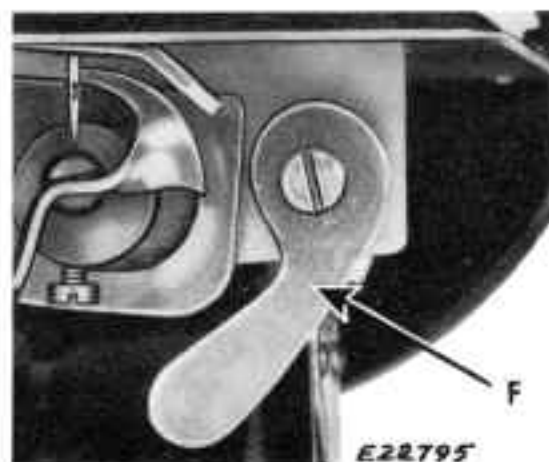

Fig. 10. To Regulate Length of Stitch

The length of stitch is regulated by lever **F**, Fig. 10. For a longer stitch, move lever **F** down away from operator. For a shorter stitch, move lever **F** up toward operator.

TO TIME FEED AND LOCATE FEED ECCENTRIC AND LOOPER

NOTE: If screw L is loosened, all adjustments (timing feed and locating feed eccentric and looper) must be made as instructed below.

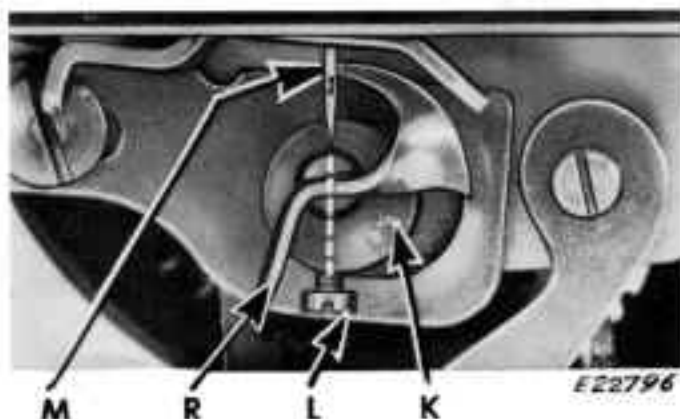

Fig. 11. Timing the Feed

To time feed, turn hand wheel over away from operator until looper point is centered with needle, as shown at M, Fig. 11. Loosen set screw L, Fig. 11 and turn feed eccentric K so that screw L is in position shown in Fig. 11.

To locate feed eccentric K, hold pinion gear Q, Fig. 17 against machine and adjust feed eccentric K for a slight amount of clearance (not to exceed .003 inch,) as shown in Fig. 11A. Do not tighten screw L at this time.



Fig. 11A. Locating Feed
Eccentric and Looper

To locate looper R, move looper as close to needle as possible as shown at D, Fig. 11A, and then, after all adjustments have been made as instructed above, tighten set screw L, Fig. 11. Re-check adjustments.

†Use .003 Feeler Gauge Serial 187928 Complete.

TO REMOVE AND REPLACE CLOTH PLATE

To remove cloth plate **U**, Fig. 12, first remove thumb screw **T** and cloth guide **Y**. Raise presser bar and needle bar to highest points. Remove screws **Z**. Lift cloth plate slightly at **U** (to clear feed dog) and slide it out between presser foot and feed dog.



Fig. 12. Removing and Replacing Cloth Plate

To replace, raise presser bar and needle bar to highest points. Pass cloth plate between presser foot and feed dog, fit cloth plate slots over feed dog teeth and replace cloth plate screws **Z**. Replace cloth guide **Y** and thumb screw **T**.

TO REMOVE AND REPLACE LOOPER

CAUTION: When removing looper, needle must be high enough for looper to pass without striking needle.

To remove looper **R**, turn hand wheel over away from operator until set screw **L** is in approximate position shown in Fig. 13. Loosen screw **L** and remove looper **R** from end of looper shaft **S**.

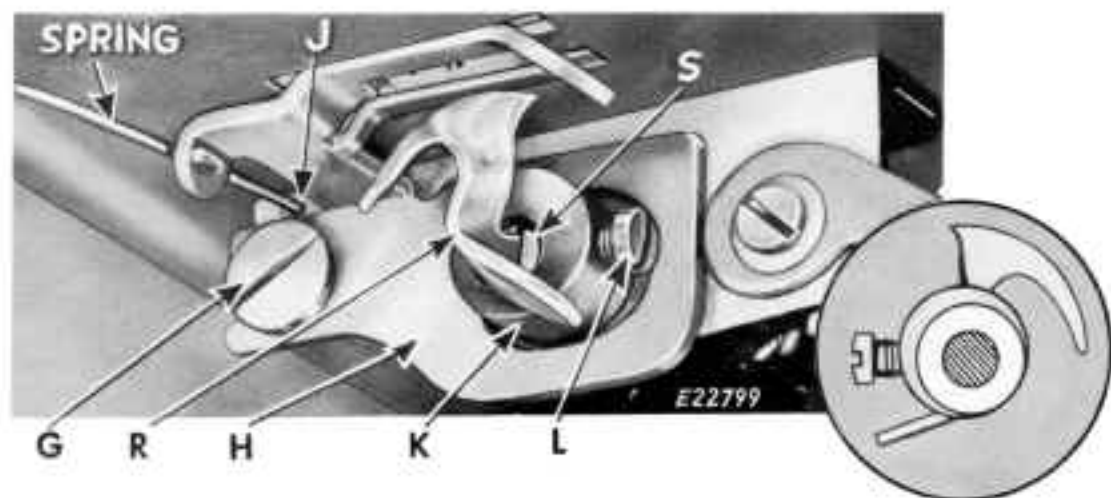

Fig. 13. Removing Looper

To replace looper, turn hand wheel until needle bar is at its highest point. Fit looper **R** (point down) into slot in looper shaft **S**. Time feed and locate feed eccentric **K** and looper **R**, as instructed on page 9.

TO REMOVE AND REPLACE FEED ECCENTRIC

To remove feed eccentric **K**, loosen screw **L** and remove looper as instructed on **page 10**. Then slide feed eccentric **K** from looper shaft **S**.

To replace feed eccentric, place raised portion, or "boss," (see inset, **Fig. 13**,) against face of machine with slot of feed dog **H**, **Fig. 13** riding on feed eccentric. Replace looper as instructed. Time feed and locate feed eccentric and looper, as instructed on **page 9**.

TO REMOVE AND REPLACE FEED DOG

To remove feed dog **H**, **Fig. 13**, first remove looper and feed eccentric. Then remove screw **G** to allow feed dog and spring to be removed.

To replace, position feed dog and spring as shown in **Fig. 13**, with end of spring in hole **J**. Replace and tighten feed dog screw **G**, **Fig. 13**, making certain that feed dog can be moved back and forth by hand. Replace feed eccentric and looper and adjust as instructed on **page 9**.

TO REMOVE AND REPLACE NEEDLE BAR

To remove needle bar:

1. Remove needle and needle set screw.
2. Remove cloth plate.
3. Remove arm side cover by first removing screws on rear side of machine which hold cover in place.
4. Turn hand wheel over until needle bar reaches its highest position.

5. Remove hinge screw **E2**, **Fig. 14**. Then disengage connecting stud **J2**, **Fig. 15** from "socket" **L2** in needle bar lever.
6. Remove connecting stud **J2** from needle bar.
7. Remove needle bar from top of machine.

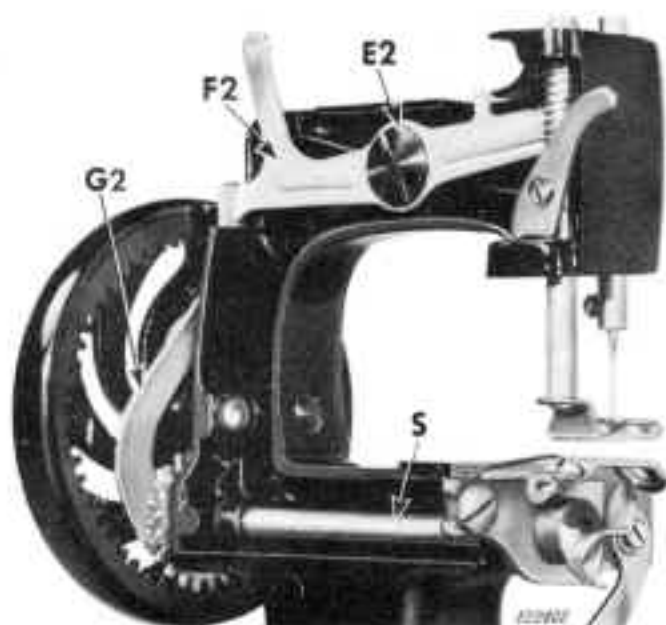

Fig. 14. Removing Needle Bar

To replace needle bar:

1. Insert needle bar so that it fits between sides of guide bracket **D2**, **Fig. 15**.
2. Insert connecting stud **J2**, **Fig. 15** in needle bar hole with round head of stud on same side of needle bar as the number "6" stamped near top of needle bar.
3. Fit round head of connecting stud **J2** into "socket" **L2** as shown in **Fig. 15**.
4. Replace and secure hinge screw **E2**, **Fig. 14**.
5. Replace arm side cover and tighten screws.
6. Replace cloth plate.
7. Replace needle and needle set screw.

TO REMOVE AND REPLACE PRESSER BAR

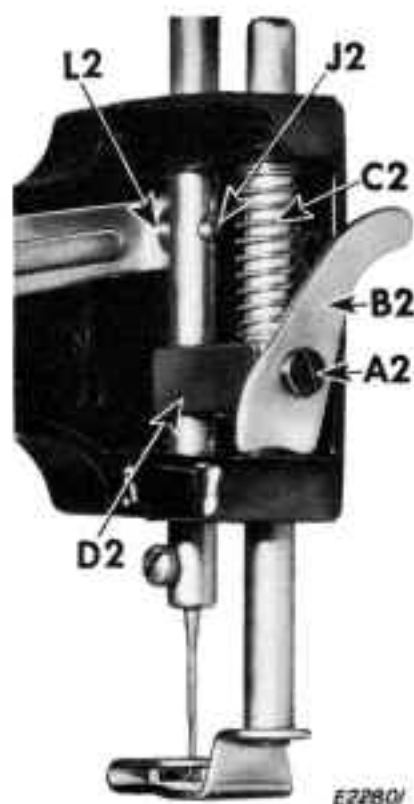

Fig. 15. Removing and Replacing Presser Bar

To remove presser bar:

1. Raise needle bar to highest position.
2. Remove cloth plate.
3. Remove looper and feed eccentric.
4. Remove feed dog.
5. Remove arm side cover by first removing screws on rear side of machine which hold cover in place.
6. Lower presser bar and remove screw **A2** and lifting lever **B2**, Fig. 15. While holding spring **C2** and guide bracket **D2** in place, remove presser bar. Then remove spring and guide bracket.

To replace presser bar, fit spring **C2**, Fig. 15 in position and slide presser bar up through bottom hole, spring, and top hole in machine arm. Compress spring from bottom and insert guide bracket **D2**

under spring, with sides of bracket straddling presser bar and needle bar. Place lifting lever in position and align holes of presser bar, guide bracket and lifting lever. Replace and tighten screw **A2**.

Replace, in order, arm side cover, feed dog, feed eccentric, looper and cloth plate.

TO ADJUST HAND WHEEL FOR CORRECT AMOUNT OF END PLAY

To adjust hand wheel for correct amount of end play, loosen set screw **N**, Fig. 16, hold hand wheel **O** against machine and adjust stud **P** for a slight amount of hand wheel end play (not to exceed .003 inch), as shown in Fig. 16. Then tighten set screw **N**.



Fig. 16. Adjusting for End Play of Hand Wheel

†Use .003 Feeler Gauge Serial 187928 Complete.

TO REMOVE AND REPLACE HAND WHEEL

To remove hand wheel **O**, Fig. 17, loosen screw **N** and remove wheel **O** and stud **P** as a unit. Slide stud **P** and wedge pin Fig. 17 from wheel and place wedge pin in a container to avoid loss.

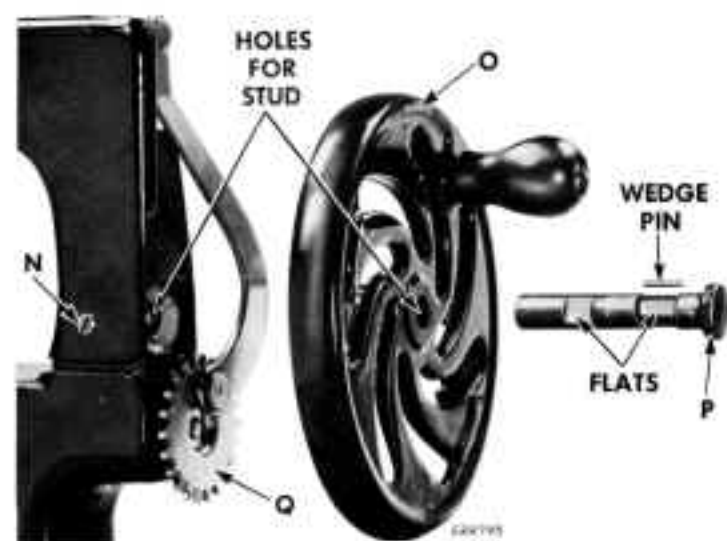

Fig. 17. Exploded View of Hand Wheel Assembly

to replace hand wheel, place wedge pin on "flat" nearest head of stud **P** and insert stud through hole in hand wheel **O**. Hold stud in hand wheel and, with "flat" of stud toward operator, insert stud into hole in lower arm of machine. Make sure that teeth of pinion gear **Q**, Fig. 17 and teeth of hand wheel **O** mesh. Adjust for end play, as instructed on page 13, and tighten set screw **N**, Fig. 17.

TO OIL MACHINE

For best results, the machine should be oiled occasionally with **SINGER* SEWING MACHINE OIL**.

Apply **one drop** of oil to each place where one part of machine is in moving contact with another.

Every six months put **one or two drops** of oil into oil hole at each end of motor of **Machine 20-2**.

SUGGESTIONS TO THE SERVICEMAN

Order of Inspection:

1. Obtain complete information concerning customer's sewing problem. Ask for sample of material and thread.
2. Check threading of machine. See Fig. 1.

3. Check relationship of needle with looper. **See page 9.**
4. Inspect needle for—
 - a. make. All SINGER needles are marked with Company's trade mark "SIMANCO**".
 - b. wear or damage. (Needle bent, blunt—needle eye rough)
 - c. relationship to presser foot and cloth plate. **See page 15**, below.
5. Check slot in presser foot and hole in cloth plate for burrs, wear or damage.
6. Be sure looper is not bent or blunt.
7. Check looper for needle point and scissor point burrs.
8. Check timing of feed. **See page 9.**
9. Be sure feed dog is not bent.

CAUSES OF NEEDLE BREAKAGE

1. Operator pulling material while machine is stitching.
2. Incorrect timing of feed. **See page 9.**
3. Incorrect location of needle in needle bar. **See page 5.**
4. Incorrect position of needle in relation to presser foot and cloth plate. **See page 15**, below.
5. Incorrect location of looper. **See page 9.**

CAUSES OF THREAD BREAKAGE

1. Incorrect threading. **See Fig. 1.**
2. Tension too tight. **See page 8.**
3. Incorrect opening of thread nipper. **See page 8.**
4. Needle blunt or bent, needle eye sharp.
5. Burr on looper.
6. Roughened hole in cloth plate.

CAUSES OF THREAD LOOPING

1. Incorrect threading. (Thread may have slipped from between tension discs.)
2. Tension too light. **See page 8.**

RELATION OF NEEDLE TO PRESSER FOOT AND CLOTH PLATE

If needle strikes presser foot or cloth plate, check for the following causes:

1. Bent needle—(Replace)
2. Worn, damaged or bent needle bar—(Replace)
3. Bent presser bar or presser foot—(Replace)
4. Bent or loose guide bracket **D2, Fig. 15**—(Correct)
5. Cloth plate incorrectly seated—(Correct)

TO START AND STOP MOTOR OF MACHINE 20-2

CAUTION: Before starting motor, be sure current is 110 volt, 60 cycle, alternating current (A. C.).

To start motor, press down on switch **H2** and lever **K2**, **Fig. 18** at the same time. Release lever **K2** and rubber roller back of hand wheel will touch rim of wheel and drive machine.



Fig. 18. To Start and Stop Motor

To stop motor, press down on switch **H2**, **Fig. 18**.

TO CHANGE SPEED OF MACHINE 20-2

Machine 20-2 has two sewing speeds; a slower speed for careful stitching, or for young children, and a faster speed for ordinary straight sewing.

To change speed, place machine in position shown in **Fig. 19**. Remove motor pulley guard **X** by pressing it down and sliding it toward you.

For slow speed, move belt to outside grooves **V** in pulleys. For faster speed, move belt to inside grooves **W**.

Replace guard **X** with slots over metal tabs in base of machine and press guard down and away from you into place.



Fig. 19. Changing Speed of Machine 20-2

Manual courtesy of
The NeedleBar